

# Operation of the GTS-LHC Source for the Hadron Injector at CERN

L. Dumas<sup>1</sup> C. Hill<sup>1</sup> D. Hitz<sup>2</sup> D. Küchler<sup>1;1)</sup> C. Mastrostefano<sup>1</sup> M. O'Neil<sup>1</sup> R. Scrivens<sup>1</sup>

<sup>1</sup> (CERN, AB/ABP/HSL, 1211 Geneva 23, Switzerland)

<sup>2</sup> (CEA, DRFMC/SBT, 17 rue des Martyrs, 38054 Grenoble Cedex 9, France)

**Abstract** The GTS-LHC ion source, designed and build by CEA Grenoble, was installed and commissioned at CERN in 2005. Since than the source has delivered oxygen and lead ion beams ( $O^{4+}$  and  $Pb^{27+}$  from the source,  $Pb^{54+}$  from the linac) for the commissioning of the Low Energy Ion Ring (LEIR). Results of this operation and attempts to improve the source performance and reliability, and the linac performance will be presented in this paper.

**Key words** operation, linear accelerator, metal ions, bias disk

## 1 Introduction

A part of the physics programme of the Large Hadron Collider (LHC) is dedicated to heavy ion collisions. Within the last years the injector chain was upgraded and modified to ensure the beam properties needed for the heavy ion operation of the LHC. As part of an intensity improvement the old ECR4 source was replaced by the GTS-LHC source<sup>[1]</sup>.

Detailed informations concerning the installation and the commissioning of the source are published in Ref. [2].

Since the middle of 2005 the source and Linac3 were running most of the time for the commissioning of the Low Energy Ion Ring (LEIR) and its injection line. There was only some limited time to study the source itself and to improve their performance.

## 2 Operational experiences

For the commissioning of LEIR and its injection line Linac3 had to deliver oxygen and lead ion beams.

For the commissioning with oxygen,  $O^{4+}$  had to

be used (similar  $q/m$  as  $Pb^{54+}$ ). To inject the beam in the RFQ the extraction voltage had to be set to 10kV (corresponds to 2.5keV/u). The source delivered  $\sim 300\mu A$  under these conditions,  $120\mu A$  were transmitted through the RFQ and at the end of the linac  $\sim 70\mu A$  were available. The beam was very stable over several weeks. After the stop of the source for inspection a strong erosion of the extraction electrodes was found.

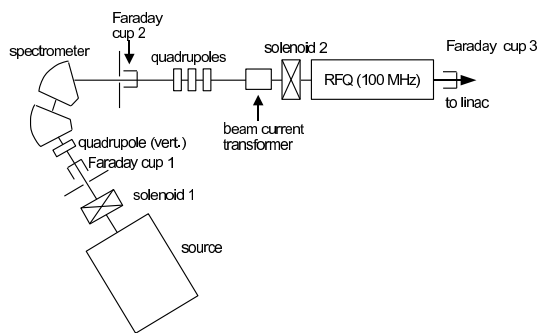

Fig. 1. Sketch of the low energy beam transport (LEBT) of linac3.

For the commissioning with lead, a  $Pb^{27+}$  beam from the source was accelerated and stripped to

Received 20 April 2007

1) E-mail: detlef.kuchler@cern.ch

$\text{Pb}^{54+}$ . During the commissioning of the source a current of  $215\mu\text{A}$  could be reached for a short time in Faraday cup 2 (see Fig. 1). But for a stable, longterm operation only up to  $104\mu\text{A}$  in Faraday cup 3 could be reached, which gave at the end of the linac up to  $17\mu\text{A}$  of  $\text{Pb}^{54+}$ .

A typical charge state distribution from the source is shown in Fig. 2.

After the LEIR set-up some optimisation of Linac3 increased the current out of the linac to  $30\mu\text{A}$  for a current of  $\sim 100\mu\text{A}$  of  $\text{Pb}^{27+}$  in Faraday cup 3 for a short period.

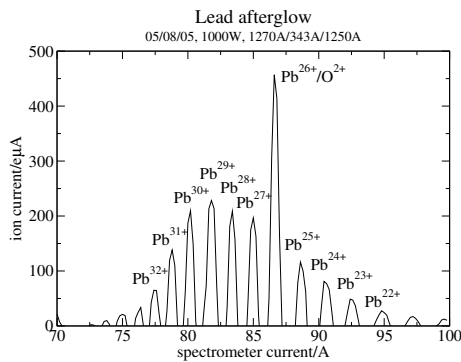

Fig. 2. Lead charge state distribution from the source.

Table 1. Ion current in Faraday cup 3, horizontal and vertical emittance versus length of the source extraction gap. The emittance is simulated with KOBRA3D. It is the rms value for the  $\text{Pb}^{27+}$  beam, the intermediate electrode is at  $-1\text{kV}$ .

gap/mm	35	40	45	50
Ion current/ $\mu\text{A}$	118	104	124	102
$\epsilon(\text{horizontal})/(\text{mm}\cdot\text{mrad})$	160	130	130	140
$\epsilon(\text{vertical})/(\text{mm}\cdot\text{mrad})$	180	200	190	170

A study was made of the extraction gap between the plasma electrode and intermediate electrode (for all measurements the distance between the intermediate and the ground electrode was kept constant). For each gap a vacuum intervention was necessary because the gap length could not be changed remotely. The source was optimised every time for three days, so the long term effect of the different gaps was not studied. The results shown in Table 1 show a maximum intensity (transmitted through the RFQ) with a gap of  $45\text{mm}$ , in comparison to the  $40\text{mm}$  gap used during the LEIR commissioning.

Some simulations were done with KOBRA3D (Fig. 3, Table 1). The acceptance of the LEBT is  $200\text{mm}\cdot\text{mrad}^{[3]}$ . The simulation results cannot fully explain the optimum extraction gap length of  $45\text{mm}$ .

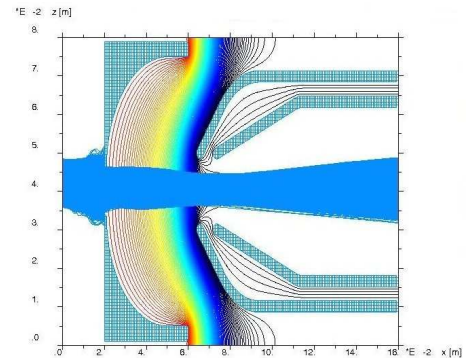

Fig. 3. Simulation of the extracted lead beam for a gap length of  $45\text{mm}$ . (The beam consists of the complete charge state distribution as in Fig. 2. The ion density distribution was modelled star-shape like).

The lead consumption during operation could be reduced to less than  $1\text{mg/h}$ , allowing the source to run for at least 14 days between oven refills. For ECR4 this time was 3 to 4 weeks.

### 3 Bias disk experiments

During the first setting up of the oxygen beam it has been found that the beam transport in the Low Energy Beam Transport (LEBT) part of the linac (Fig. 1) was strongly dependent of the setting of the bias disk voltage.

Zavodszky et al.<sup>[4]</sup> showed that the transverse emittance of the ARTEMIS source for the  $\text{O}^{3+}$  beam increases with increasing bias disk voltage. Unfortunately there is no direct possibility to measure the emittance at Linac3. For an indirect measurement the transmission between Faraday cup 2 and Faraday cup 3 (see Fig. 1) was determined. The acceptance of the elements between the two Faraday cups is in this case the limiting factor for the transport, and this could give an estimation of the maximum emittance.

The first experiments were done with  $\text{O}^{2+}$ . The Figs. 4 and 5 show the ion current in the Faraday cups 2 and 3 for pulsed and cw operation of the RF and the bias disk voltage. It is clearly visible that with higher bias disk voltage the current in Faraday

cup 2 increases, but this current can't be transported down to Faraday cup 3 (Fig. 6). The effect is worse for cw

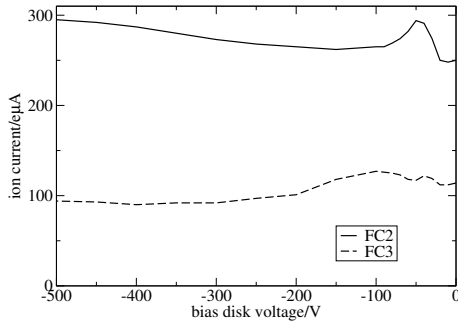

Fig. 4.  $O^{2+}$  ion current in Faraday cup 2 and

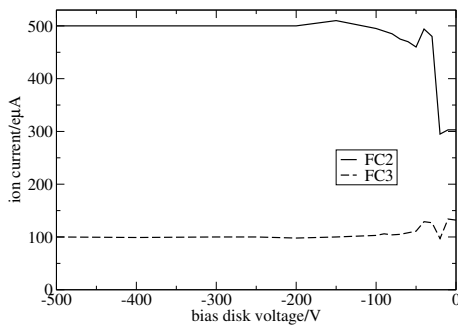

Fig. 5.  $O^{2+}$  ion current in Faraday cup 2 and

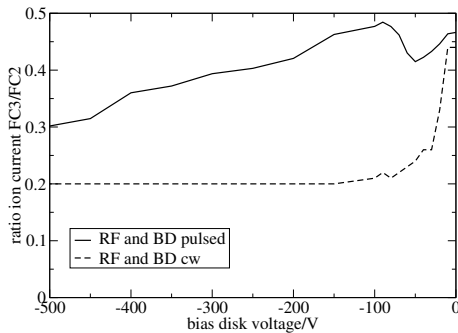

Fig. 6. Transmission of the  $O^{2+}$  ion beam between Faraday cup 2 and 3.

Further experiments were done with  $Pb^{27+}$  in afterglow mode. Fig. 7 shows the transmission of the lead ion beam. In comparison with oxygen the transmission is much higher but there is still a slight dependence from the bias disk voltage. Fig. 8 shows the ion current in Faraday cup 3 as a function of the bias disk voltage and the operation mode (pulsed or cw). In general the pulsed mode gives more current than the cw mode. For higher bias disk voltage the cw mode even reduces the afterglow mode ion current. The large variations of the ion current between

-200V and -300V in the pulsed mode are due to instabilities during the ion pulse (see also Fig. 9(b)). The ion current “jumped” between two stable states.

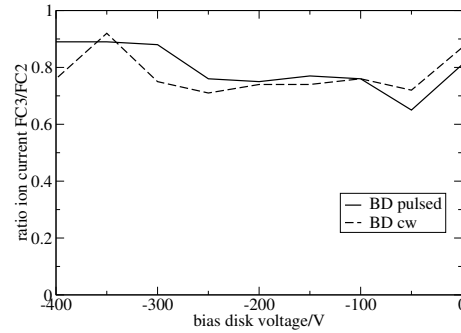

Fig. 7. Transmission of the  $Pb^{27+}$  ion beam between Faraday cup 2 and 3.

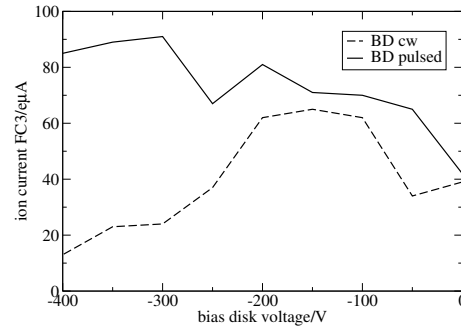
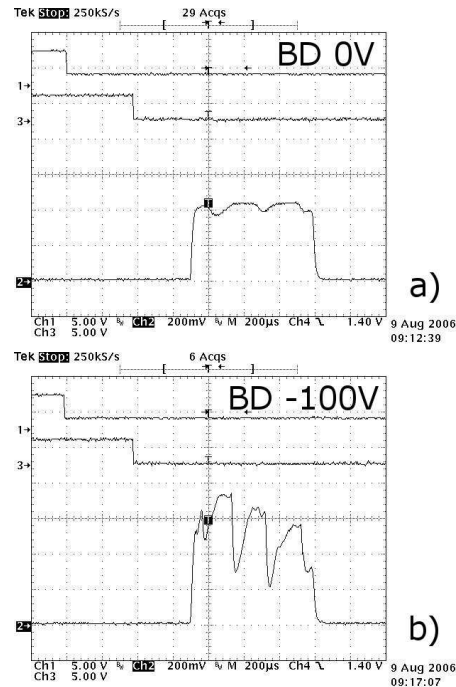

Fig. 8.  $Pb^{27+}$  ion current in Faraday cup 3 for pulsed and cw bias disk voltage.



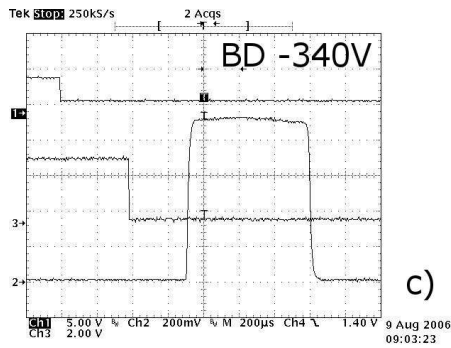

Fig. 9. Traces of the lead ion beam in Faraday cup 3 for different bias disk voltages. (trace 1: bias disk voltage, trace 2: ion current, trace 3: RF pulse).

Figure 9 shows some traces of the lead ion beam measured in Faraday cup 3. Fig. 9(a) shows the normal afterglow (only a time slice of  $700\mu\text{s}$  is transported through the RFQ). Fig. 9(b) shows the enhancement of the afterglow for  $-100\text{V}$  bias disk voltage, but it shows a instability during the pulse. Fig. 9(c) shows the optimised pulse, with a high intensity and a smooth pulse shape.

The result of this experiments give some guidance for further source set-ups. Even if the ion current out of the spectrometer (in Faraday cup 2) is maximised this should not mean that a maximum current out of

the RFQ (in Faraday cup 3) or out of the Linac3 can be expected. The optimisation of the source for the linac operation should therefore be done with Faraday cup 3 and after the linac.

The stabilisation of the afterglow pulse and the enhancement due to the pulsed bias disk voltage were already reported for experiments with the ECR4 source<sup>[5]</sup> and are now confirmed with the GTS-LHC source.

## 4 Conclusion

The commissioning of LEIR was successful and the early beam for the LHC heavy ion operation could be prepared. The source showed a good performance and reliability and most of the problems shown up during the source installation and commissioning could be solved meanwhile.

The behaviour of the beam from the source as a function of the bias disk voltage showed some interesting effects. A reproduction on another source in afterglow mode with some emittance measurements is necessary. Also a theoretical model how the bias disk voltage influences not only the beam intensity but also the beam quality is needed.

## References

- Hill C E, Kuchler D, Scrivens R et al. GTS-LHC: A New Source For The LHC Ion Injector Chain. AIP Conf. Proc., 2005, **749**: 127—130
- Hill C E, Kuchler D, Mastrostefano C et al. Experience with the GTS-LHC Ion Source. Proc. 3rd LHC Project Workshop Chamonix XV, 2006. 239—241
- Angert N et al. CERN Heavy-Ion Facility Design Report. CERN 93-01, 1993
- Zavodszky P A, Koivisto H, Cole D et al. Emittance Studies Of ARTEMIS – The New ECR ION Source For The Coupled Cyclotron Facility At NSCL/MSU. AIP Conf. Proc., 2001, **576**: 619—622
- Hill C E, Kuchler D, Wenander F et al. Effect of a Biased Probe on the Afterglow Operation of an ECR4 Ion Source. Rev. Sci. Instrum., 2000, **71**: 863—865